

EN

INSTALLATION INSTRUCTIONS

INSTALLATION/CARE/MAINTENANCE/SAFETY INSTRUCTIONS

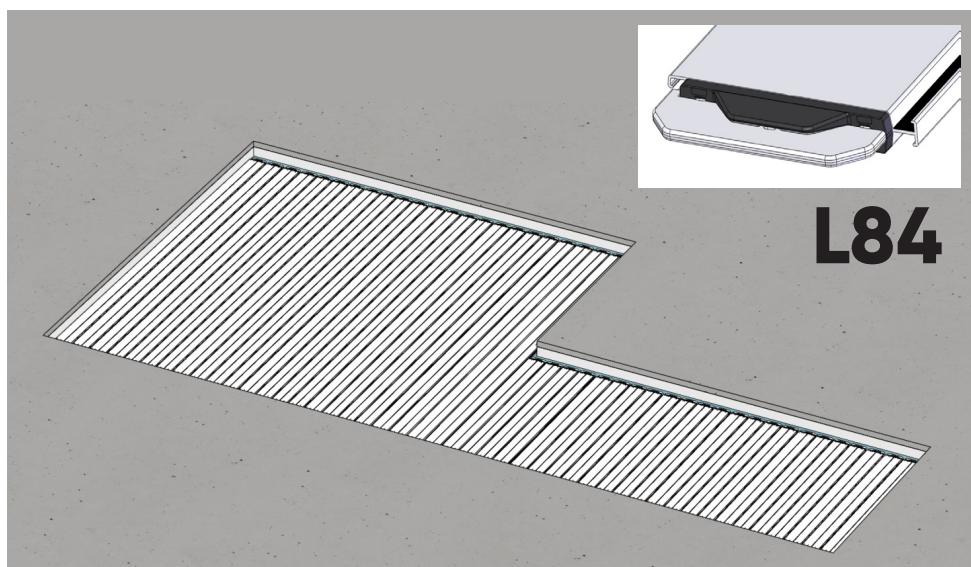

L84

SLATTED COVER

84 MM PVC SLATS

CONTENTS

PLEASE READ THESE INSTRUCTIONS CAREFULLY AND KEEP THEM FOR FUTURE REFERENCE

Please read this manual carefully to help you understand all of the information and to ensure safe installation, use and servicing. We are not held liable for any damage arising due to a failure to respect the instructions set out in this manual.

INFORMATION	3
Components	3
Tools.....	4
Assembly time	4
Packing list.....	4
Prerequisite.....	5
INSTALLATION	6
Slat construction.....	6
Slat assembly	8
Slat removal.....	10
Remove the flange.....	10
Above-ground roller	11
Submerged roller	12
Locking kits.....	13
Pushlock installation.....	14
Pushlock locking and unlocking.....	18
CARE / MAINTENANCE	19
Opening/closing the pool.....	19
Pool water level.....	20
Filtration & water treatment.....	20
Care (responsibility of the customer)	20
Winterising.....	21
Maintenance.....	21
SAFETY INSTRUCTIONS	22
RECYCLING	24
Packaging	24
End of life	24

INFORMATION

COMPONENTS

SLATTED COVER

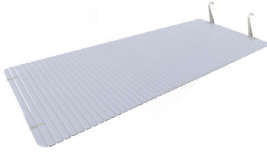

- The slatted cover is made of watertight and interconnected slats that float on the surface of the water.
- The total space between the wall and the cover must be ≤ 70 mm.
- The slatted cover is connected to the tube with straps attached to the first slat of the cover.
- Both ends of the slatted cover are equipped with straps to bind together the cover and the wall-mounted locking kits.

LOCKING KITS: PUSHLOCK

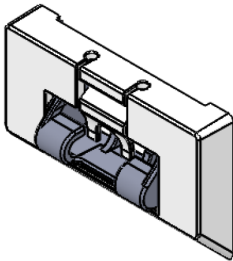

- 3 types of fixing : surface mount / insert mount / hanging mount.
- The locking kits are positioned along the width of the pool (the number and position vary depending on the pool layout).



- **Currently, DEL covers with a removable shape on a lateral set of steps do not comply with the NF P 90-308 standard.**
- **Except where the alarm manufacturer states otherwise, immersion pool alarms are not compatible with DEL automatic covers.**

INFORMATION

TOOLS



ASSEMBLY TIME



3 hours



2 people



PACKING LIST

e.g. for a 4 x 8 m pool		
Slatted cover	4 parcels measuring 4.3 x 0.4 x 0.30 m	120 kg
Pushlock	1 parcel measuring 0.20 x 0.20 m	5 kg
Total weight		125 kg

INFORMATION

PREREQUISITE

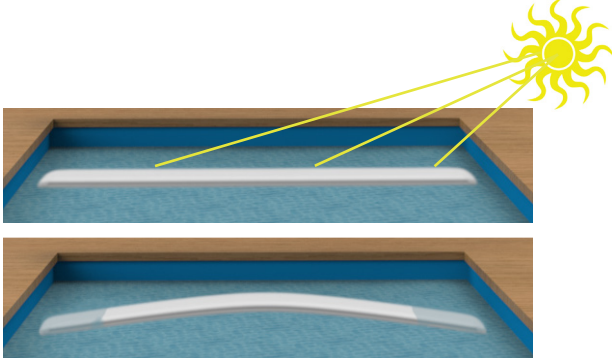
! WE RECOMMEND READING ALL THE INSTALLATION STEPS BEFORE INSTALLING THE SYSTEM, TO AVOID UNNECESSARY HANDLING.

	 <p>When the deck is in direct sunlight, the slats may become deformed due to the temperature difference with the water in the pool. They will return to their original shape as soon as the temperature is more even.</p>
	<p>Remember to use safety equipment.</p>
	<p>The minimum water level must be 8 cm below the top edge for L84 blades</p>

INSTALLATION

SLAT CONSTRUCTION

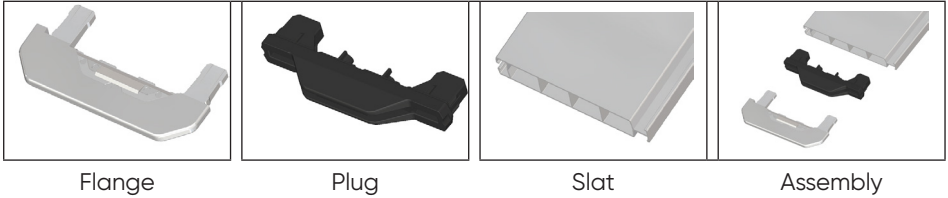

Flange

Plug

Slat

Assembly

SLAT POSITIONING

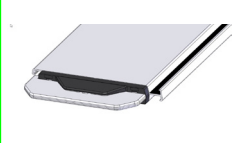
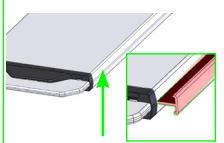
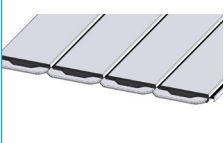
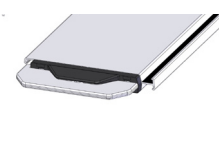
L1 slat	L1 end slat	L4 slat	L1 adjustment slat
			
<p>1 Roller-end slat with slots to allow tube straps and Pushlock straps to pass through.</p>	<p>2 L1 slats without the male connector.</p>	<p>3 Install all the L4 slats.</p>	<p>4 If you have additional L1 slats, place them here. It is not necessary to install them all.</p>

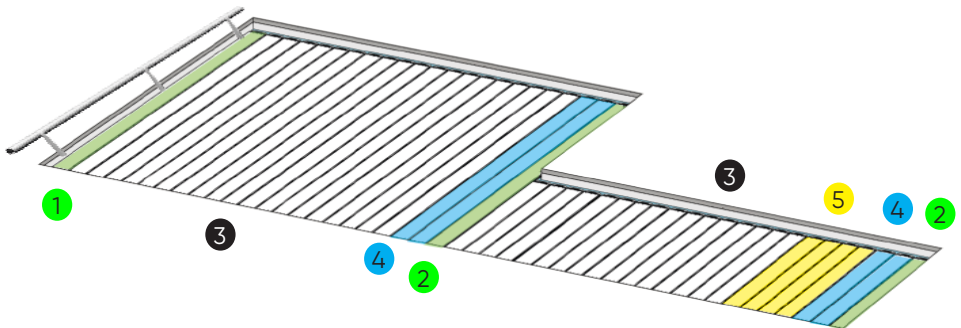

INSTALLATION

SPECIFIC CONFIGURATION FOR ABOVE-GROUND REELS

L4 slat
anti-adhesion

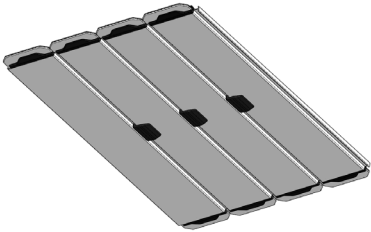

5 1st L4 slat on the opposite side to the roller with anti-adhesion stops.

Configuration of the 1st L4 slat

The slat must be assembled so that the three black stops are on the underside of the slat (water side) when the roller shutter is deployed on the pool.

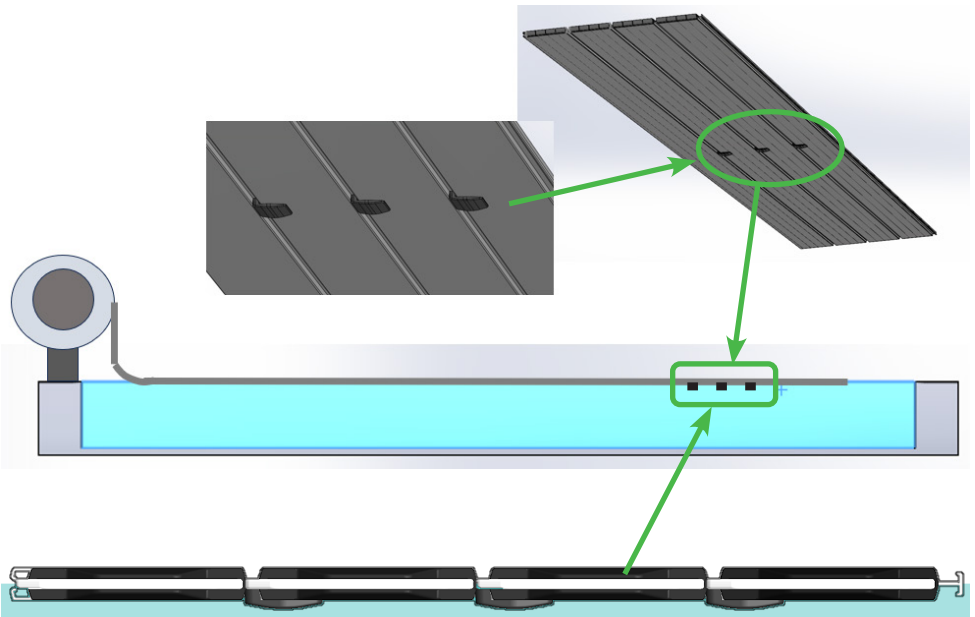
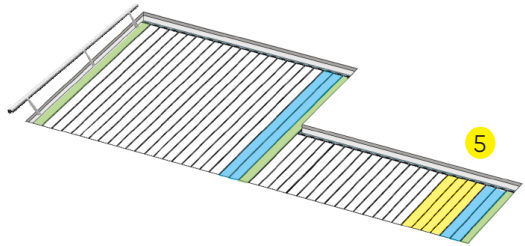

INSTALLATION

SLAT ASSEMBLY

SLAT ORIENTATION

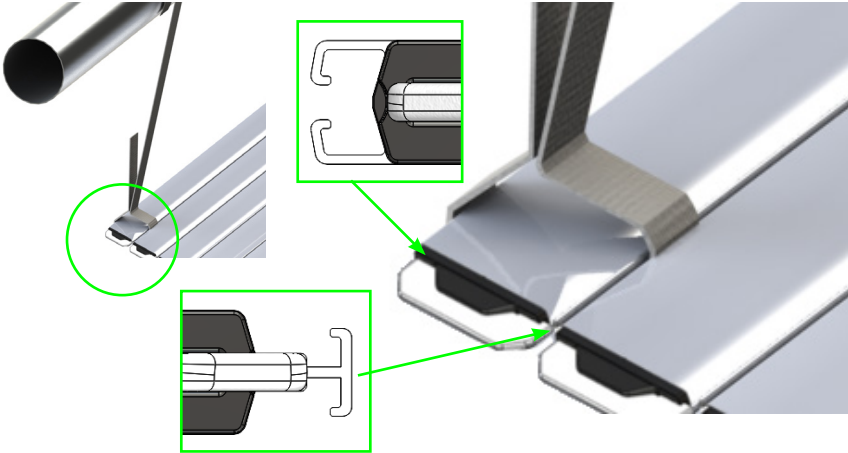

SLAT AND FLANGE INSTALLATION

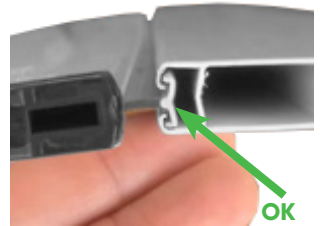
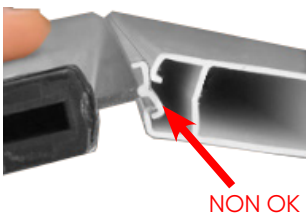
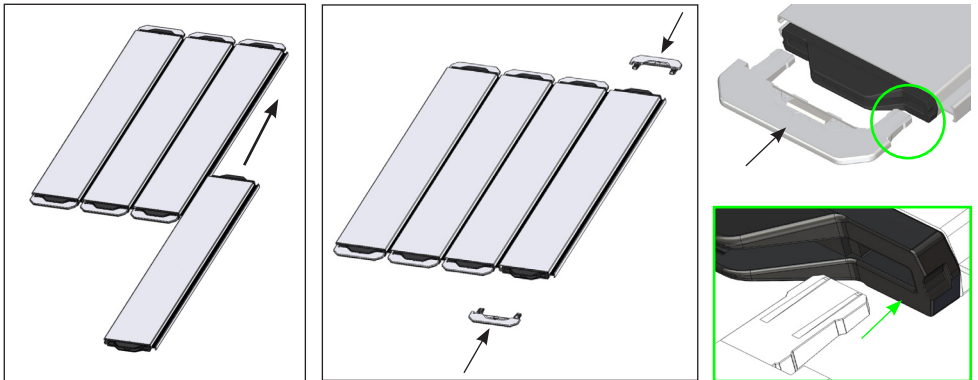

INSTALLATION

SLAT REMOVAL

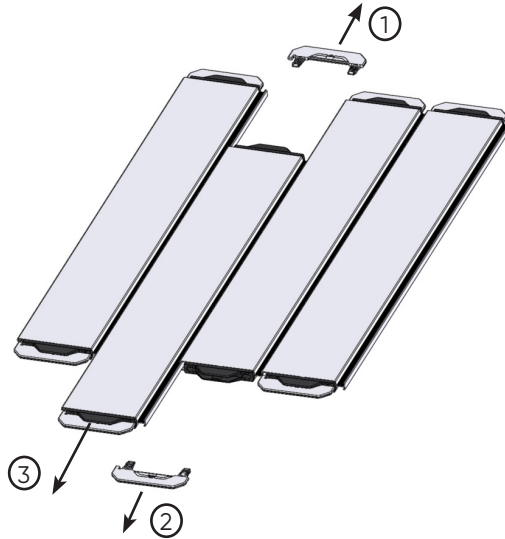

REMOVE THE FLANGE

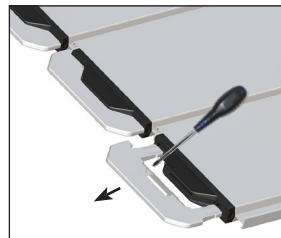
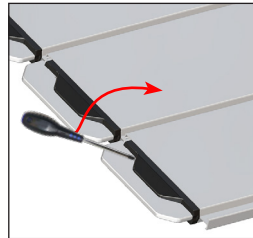
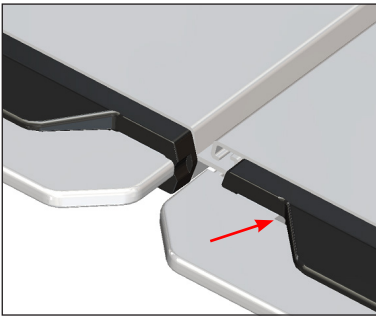

INSTALLATION

ABOVE-GROUND ROLLER

STRAP INSTALLATION

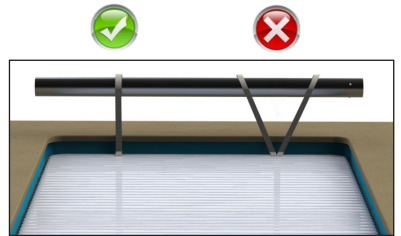
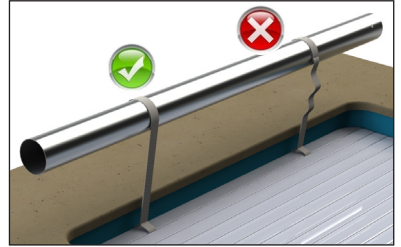
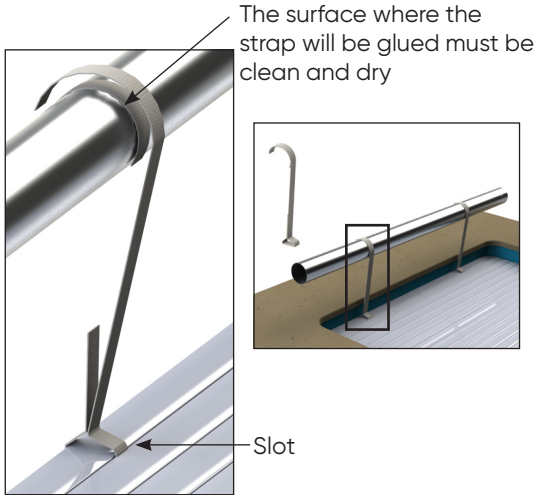

SKI INSTALLATION

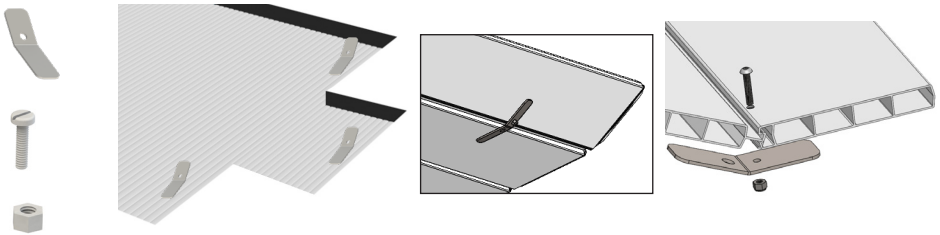

! Use a stainless steel screwdriver.

ADDITIONAL INFORMATION

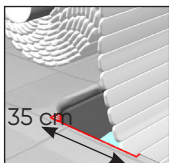

If necessary, use the grinder on the coping stones to facilitate the movement of the slatted cover and prevent abrasion.

INSTALLATION

SUBMERGED ROLLER

STRAP INSTALLATION

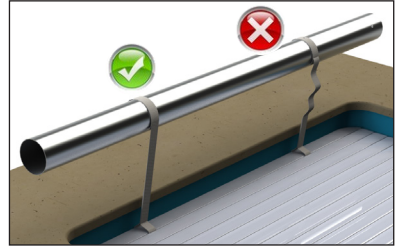
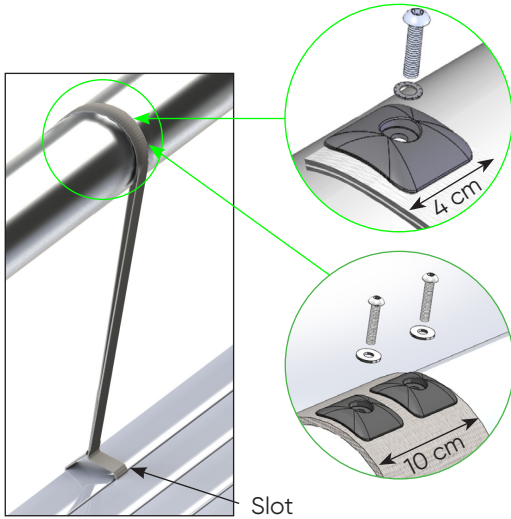

CATCH HOOK INSTALLATION

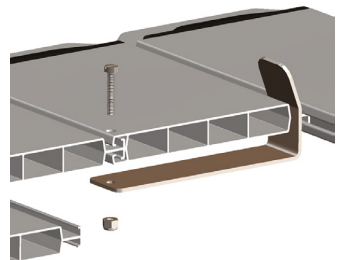
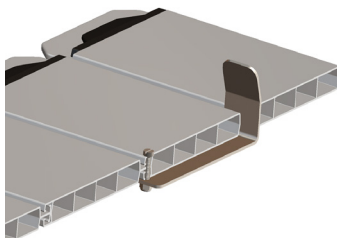
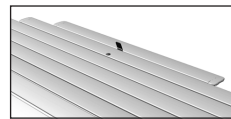
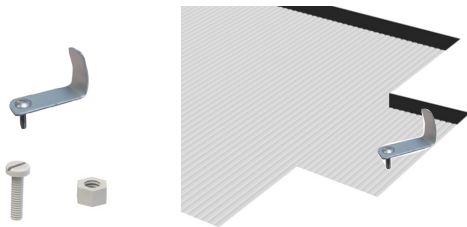

INSTALLATION

LOCKING KITS

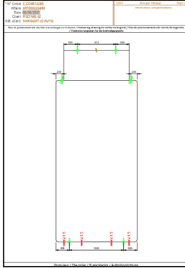

The positioning of locking kits in the pool is indicated on the drawing delivered with the slats.

All modifications to the positioning of the kits must comply with the rules explained below.

For all other cases, please contact us.

POSITIONING RULES

Without steps

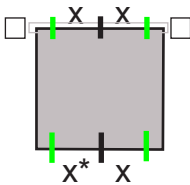

With side steps

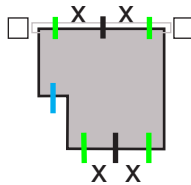

With straight steps

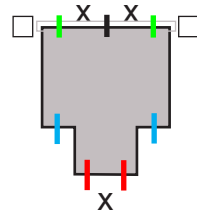

— kit 50 cm max. from the edge

— 1 kit centered if < 1 m
— 1 kit 50 cm max. from the edge if < 1.50 m
— 2 kits if > 1.50 m

— 2 kits 50 cm max. from the edge



- The distance between 2 locking kits cannot exceed 1.50m.
- Quick-lock and passesangle are not suitable for use with 84 blades.
- Replacing a standard Push Lock with an adjustable one = non-compliant.
- The straps must be adjusted as tightly as possible to limit the space between the wall and the slats.

INSTALLATION

PUSHLOCK INSTALLATION

! A water level regulator is strongly recommended

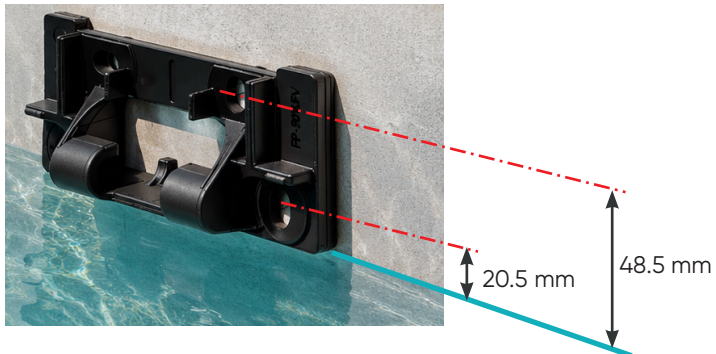
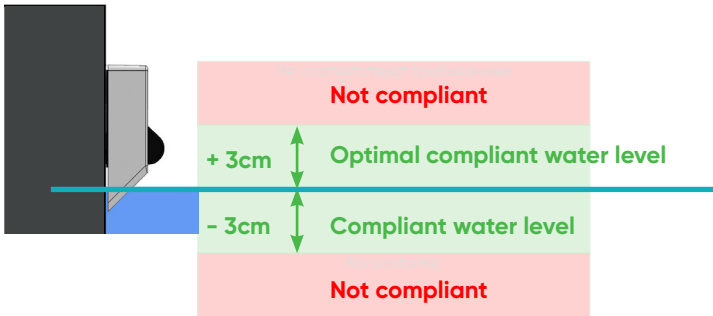

INSTALLATION

INSERT MOUNT VERSION

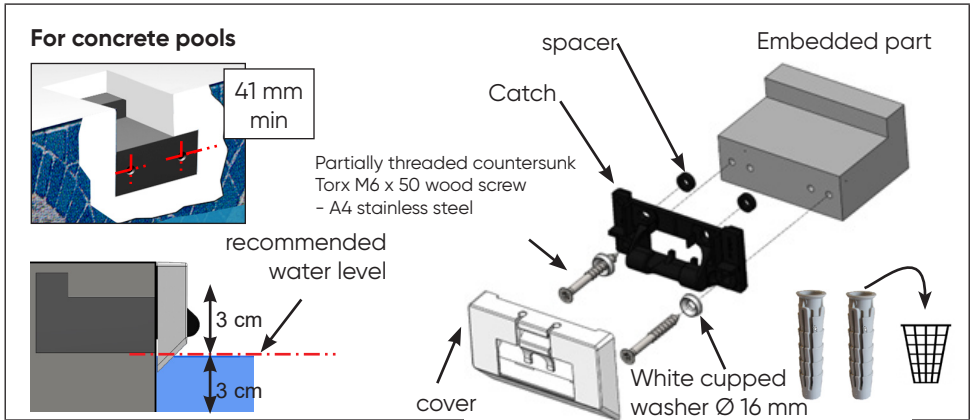

HANGING MOUNT VERSION (AND HIGH WATER LEVEL)

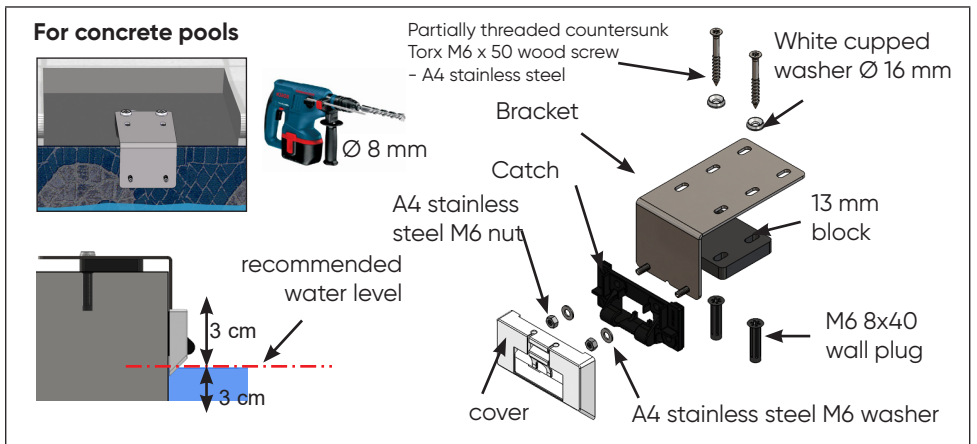

INSTALLATION

SURFACE MOUNT VERSION WITH COVER

For concrete and breeze block pools, as well as pools with a wall thickness greater than or equal to 8 mm

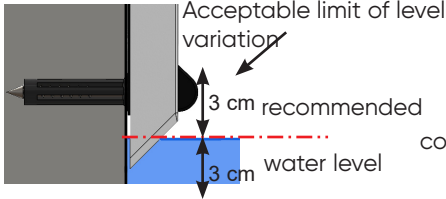
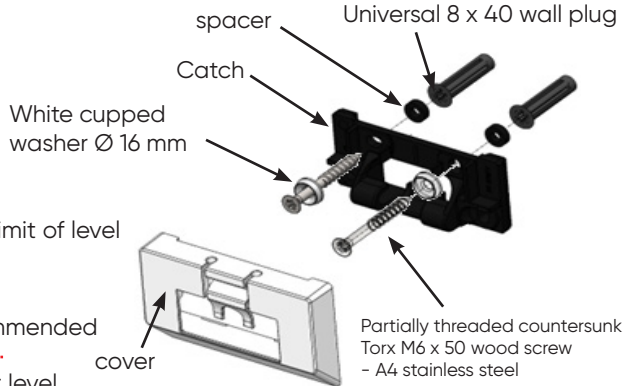
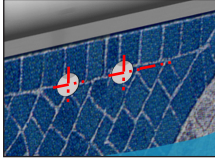

Position of push-lock according to desired water level

● do not use

● can be used

● to be used

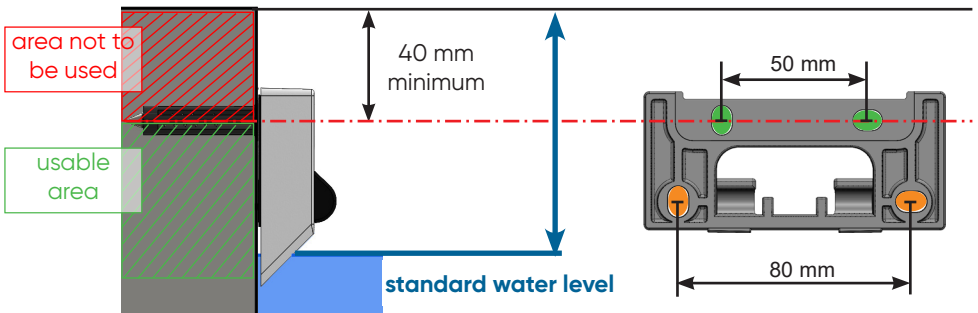
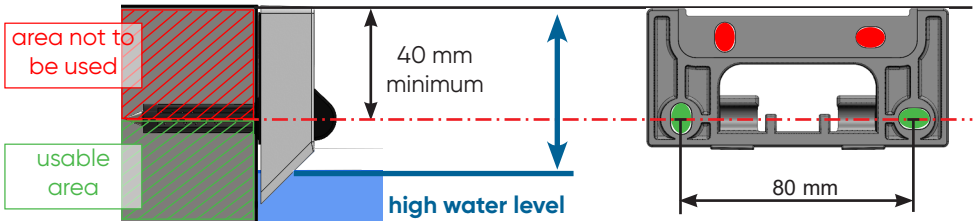

INSTALLATION

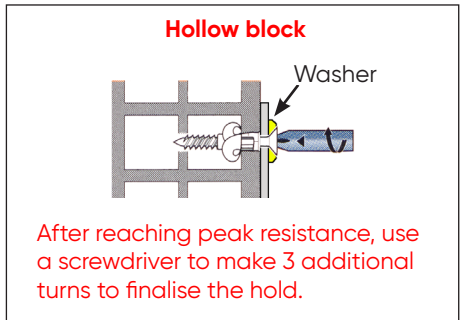
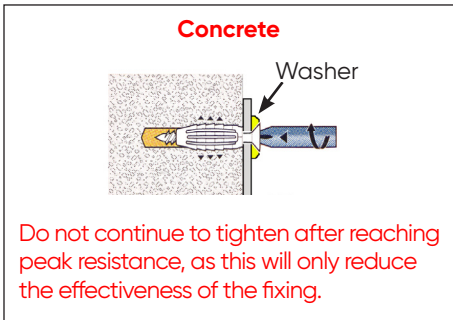
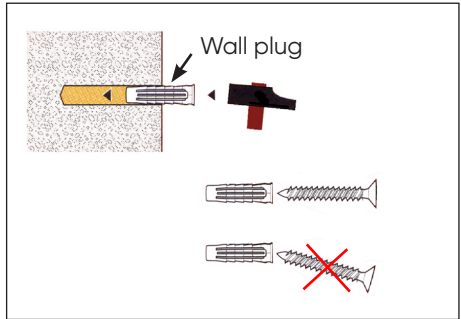
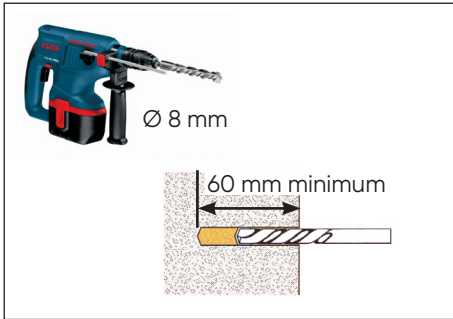

USE

PUSHLOCK LOCKING AND UNLOCKING

LOCKING

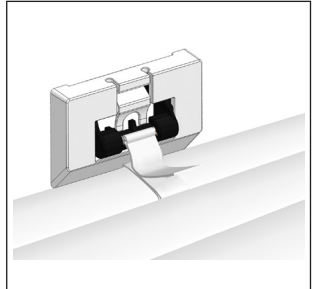
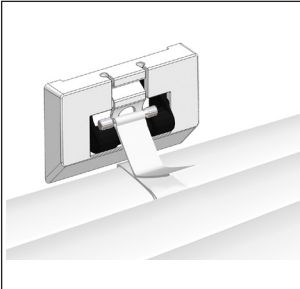
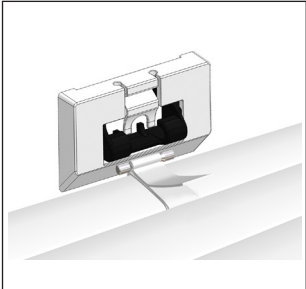

UNLOCKING

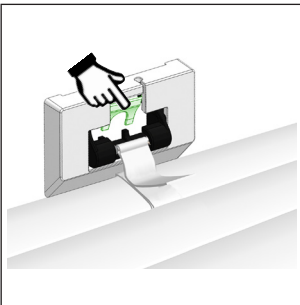
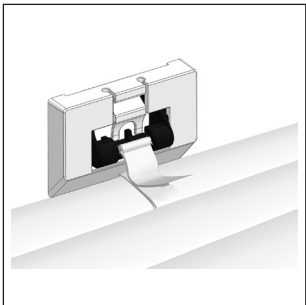

An instructional video is available via the attached QR code.



<https://youtu.be/eoYalRbMWVE>

CARE / MAINTENANCE

OPENING/CLOSING THE POOL

ALWAYS CHECK THAT THE POOL WATER LEVEL IS CONSTANT AND IS IN LINE WITH THE RECOMMENDATIONS SET OUT IN THIS MANUAL.
WHEN OPENING OR CLOSING THE COVER, YOU MUST ENSURE THAT THERE ARE NO SWIMMERS IN THE WATER AND ALWAYS KEEP AN EYE ON THE POOL.

- It is essential that the slatted cover is fully opened or closed. Never leave it halfway open.
- When using an automatic cleaner under the cover, check that the hose does not interfere with the movement of the slats when opening and closing the cover.
- It is essential that floating objects are removed from the surface of the water when closing the cover.
- Do not obstruct the slatted cover during rolling or unrolling.
- Do not operate the slatted cover in cases of frost.
- Opening and closing the pool requires a single person (the process takes 2 minutes), and locking or unlocking the locking kits takes around 30 seconds.
- Never leave an object on the cover (towel, rubber ring, etc.) because strong sunlight can cause the slats to expand locally and the warranty will no longer be valid.
- Never cover a slatted cover with a product not designed for this purpose as the slats may become misshapen.

CARE / MAINTENANCE

Any person working on the electrical parts must be qualified and must comply with the manufacturer's instructions and with the standards and regulations in force.



During any work, the technician must wear his PPE (personal protective equipment): gloves, glasses, mat, etc.

We recommend cutting off power to the installation before any work.

POOL WATER LEVEL

- For optimum safety and to ensure for the cover to work properly, always check that the pool water level remains constant and is in line with the manufacturer's recommendations (for better comfort, use an overflow and a water level regulator).
- A level that is too high is the result of an overflow that is blocked by leaves or other objects.
- A level that is too low creates the risk of blockages.
- If the pool is built with a groove or a handrail, the water level must be controlled by a level regulator.

FILTRATION & WATER TREATMENT

- Schedule filtering during the hours the pool receives direct sunlight and have it running constantly when the water reaches 25°C.
- In order to guarantee the longevity of your installation, the pool water must be correctly treated according to the standards and recommendations in force (NF EN 16713-3)
- The pH, TH and TAC of the water should be checked and adjusted as often as necessary (however, care should be taken not to correct these 3 parameters independently of each other, but to do so using the Taylor table and balance the water according to the 3 parameters analysed).

CARE (RESPONSIBILITY OF THE CUSTOMER)

- Clean your slatted cover thoroughly twice a year (when opening the pool for the season and when winterising it). This is even more important if your pool water is hard. To do this, use a descaling cleaner (see catalogue) and rinse with a water spray.
- Inspect the entire system if an abnormal load is placed on the cover (for example in the event of a fall).
- Inspect the straps annually.
- Do not wash IPE duckboard with a high pressure washer, we recommend washing them regularly with clean water and a non metallic brush.

CARE / MAINTENANCE

WINTERISING

- Winterise the pool in a way that is adapted to its geographical location.
- Use the safety position to lock the cover.
- We recommend that you install the Ivern a winter shift or an Ivern a Plus protective shift to protect the slatted cover from UV rays and dirt.

MAINTENANCE

- All repairs must be carried out by a professional, who will contact the manufacturer if necessary.
- All spare parts must be original or comply with standards.
- Inspect the entire slatted cover.
- At the start of the season and in the event of an incident (a person falling, hail on the cover, abnormal force on the cover, etc.), it is essential to check that the slats do not show any visible damage that could compromise the cover's safety function (slats with cracks, holes, distortion, etc.). Replace the slats or the entire cover if necessary.
- In both summer and winter, do not place an opaque cover on top of the slatted cover.

This risks damaging the slats due to increased temperatures.

SAFETY INSTRUCTIONS

Dear customers,

Thank you for the confidence you have placed in us by selecting our product.

Please read the below recommendations carefully.

WARNING

Swimming pools can be extremely dangerous for your children. Drowning can occur very quickly.

Children near a pool require your constant vigilance and active attention, even if they can swim.

Learn lifesaving techniques.

Having a responsible adult physically present is essential whenever the pool is open.



Memorise the numbers for the emergency services and display them near the pool.

☎...or 112

FIRE BRIGADE



AMBULANCE
SERVICE

(write the number for your region)



POISON CONTROL
CENTRE

SAFETY ADVICE

- This section is by no means a replacement for common sense or individual responsibility. Its aim is not to replace the vigilance of parents and/or responsible adults, who remain the essential factor in ensuring the protection of young children.
- **Warning:** safety is only guaranteed when the cover is closed, locked and correctly installed in compliance with the manufacturer's instructions.
- The cover must systematically be closed if you are absent from home, even for a very short period.
- Check that no persons and no foreign objects are in the pool before and during opening and closing operations.
- Store the devices and/or tools needed to operate the covers out of the reach of children.
- Operation of the mechanism must only be carried out by a responsible adult.
- With the exception of movable floors, movable terraces and the covering elements provided for this purpose (e.g. gratings), do not climb, walk or jump on a safety cover.
- Take all necessary measures to prevent access to the pool for young children until the cover is repaired or when a malfunction is observed that prevents closing or in case of temporary unavailability of the equipment or the pool.
- Respect the water levels designated by the manufacturer.

A child can drown in less than 3 minutes, no type of protection can ever replace the watchful eye and vigilance of a responsible adult.

RECYCLING

PACKAGING



Dispose of the packaging in line with current rules and regulations.

END OF LIFE



- Do not throw away your discarded equipment or used batteries with unsorted household waste.
- It is your responsibility to dispose of all your waste, particularly electrical and electronic equipment, by taking it to a dedicated collection point for recycling.
- Certain products potentially contain substances that are hazardous to the environment, and these will be removed or neutralised.
- Find out about existing take-back and collection systems.



discard the manual in line with the current regulations.



Adresses sur quefairedemesdechets.fr

NOTES

NOTES

NOTES

DEL SAS
ZA LA BASSE CROIX ROUGE
35530 BRÉCÉ - FRANCE

☎ +33 (0)9 70 72 5000 / INFO.FR@CF.GROUP

STAMP