

# SOLID WINTER SAFETY COVER

Safety cover for swimming pools, designed to prevent access to the pool during winter for children under the age of 5. Another safety system must be used while the pool is in use.

READ carefully and keep for future reference.  
The user must be provided with the notice after assembly.



## LAKE

Winter safety cover for swimming pools, designed to prevent access to the pool for children under the age of 5.

Compliant with the NF P 90-308 standard (December 2006)



**THE USER MUST BE PROVIDED WITH THE NOTICE AFTER ASSEMBLY  
READ CAREFULLY AND KEEP FOR FUTURE REFERENCE**

## PACKAGING (e.g. - for a 5 x 10 m pool with a Ø3 m ladder)







1 box of 0.80 x 0.60 x 0.40 m  
Total weight: 30 to 50 Kg

## TRANSPORT



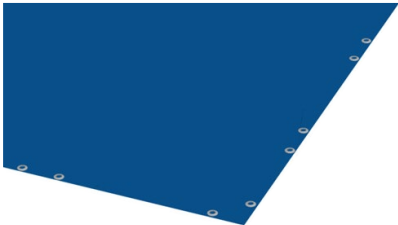



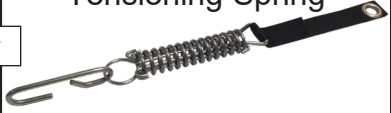

The goods are transported at the risk and peril of the recipient. If the recipient notes any damage that has occurred during transport when receiving the goods, they must immediately note their reservations on the carrier's delivery note. They must confirm these reservations within 48 hours by sending a registered letter to the carrier.

## DELIVERED ITEMS

 PVC fabric 580g/m <sup>2</sup>	P evolution Eyelet Peg Anchorage 	or Concrete Anchorage 	or Wood Anchorage 
	Click tensioning bungee 	or Tensioning Spring 	

## TOOLS REQUIRED FOR ASSEMBLY

 Ø6 concrete Ø12 concrete Ø13 wood			
			

## ASSEMBLY INFO

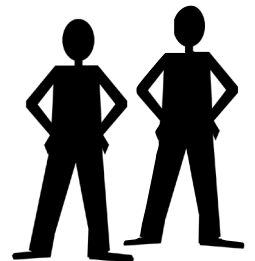
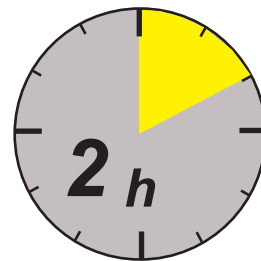

## IN ORDER FOR YOUR COVER TO COMPLY WITH THE NF P 90-308 STANDARD

- water level: from 7 to 20 cm
- The pool must be equipped with an overflow system or a water level regulator.
- No variations in the height of surround caps is accepted.

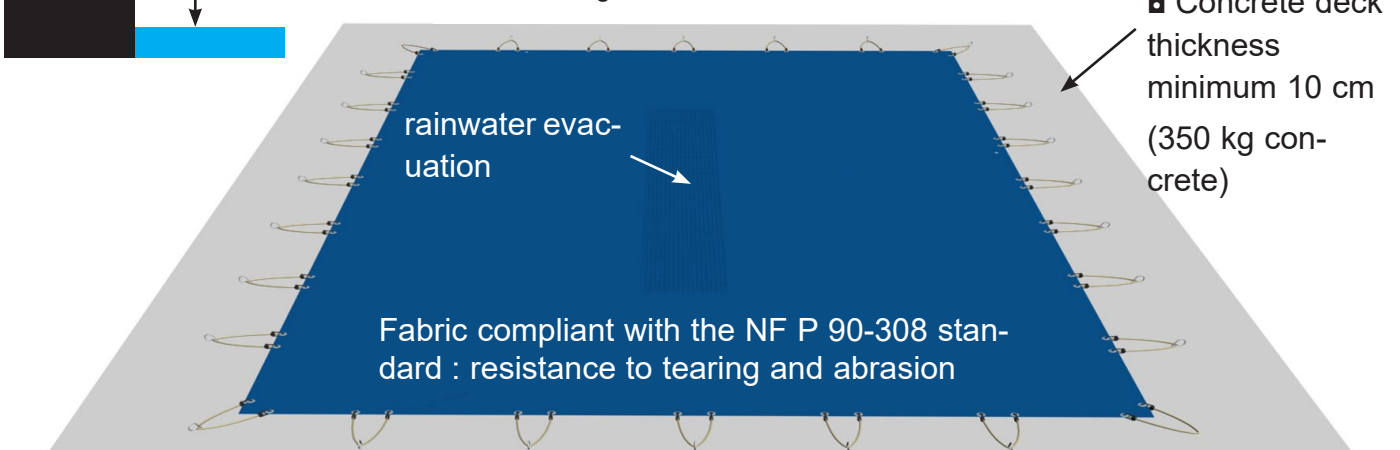

- For a cover with a standard 35 cm overlap, the deck must extend at least 80 cm for the springs, and at least 95 cm for the click bungees, around the full circumference of the pool. Alternatively, there must be at least 10 cm available after the anchor points.

## INSTALLING THE COVER

The cover must have a standard and regular **35 cm** overlap (approx.) around the full circumference of the pool.

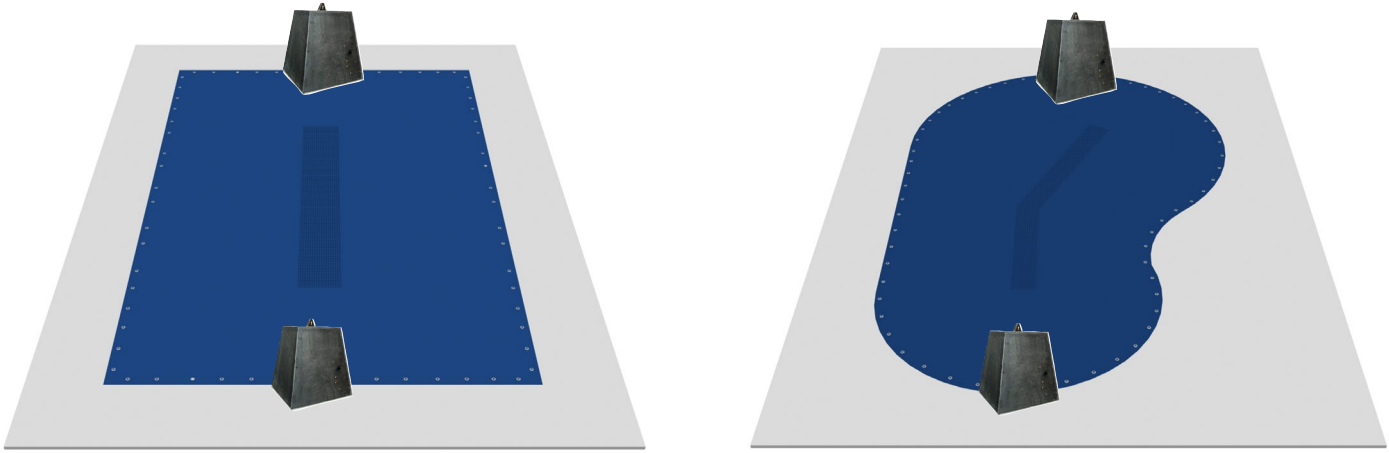

Use weights to prevent the cover from slipping into the pool.

## TRACING THE ANCHOR LINE AND ANGLES

*Rectangular shape:*

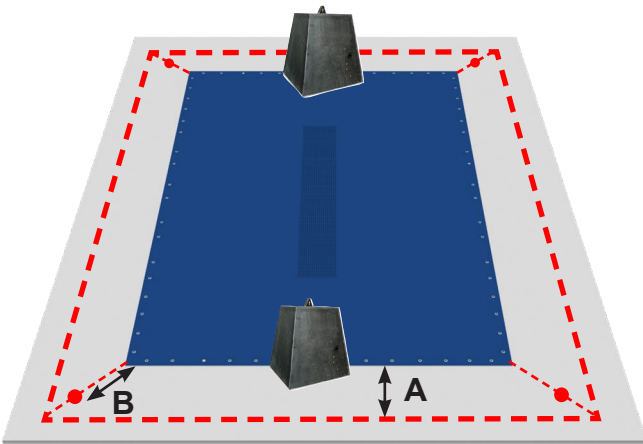

*Free-form shape:*

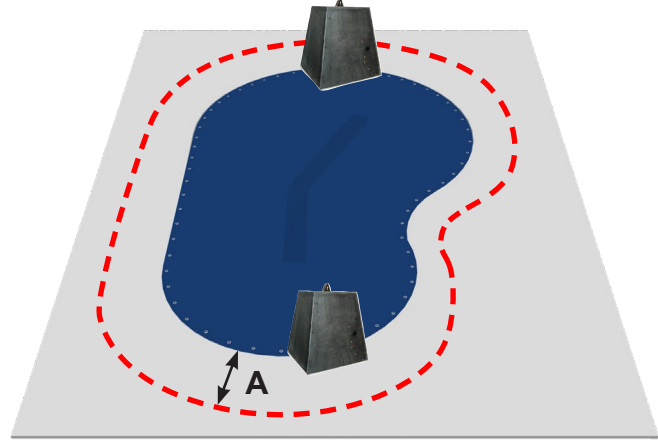

Use chalk or a string-line



+



→ **A = 50 cm**  
**B = 40 cm**

+



→ **A = 35 cm**

## EYELET PEG / ANCHORAGE

### EVOLUTION EYELET PEG P (CONCRETE)

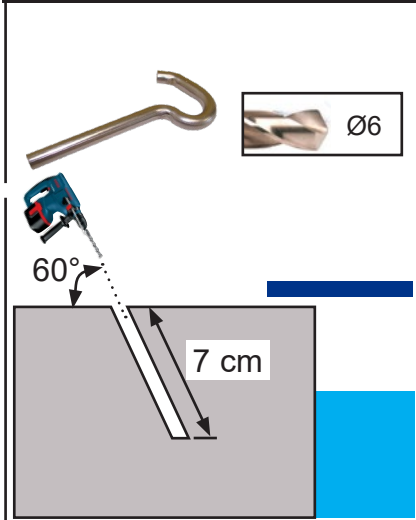

### CONCRETE ANCHORAGE

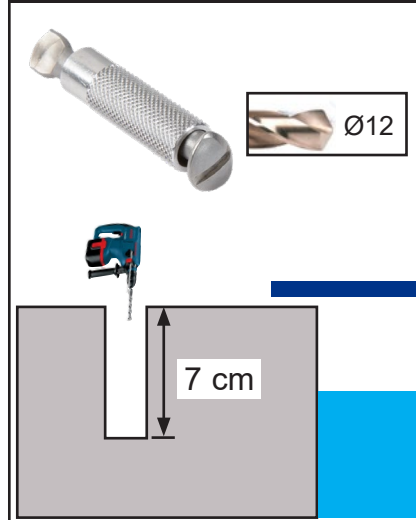

### WOOD ANCHORAGE

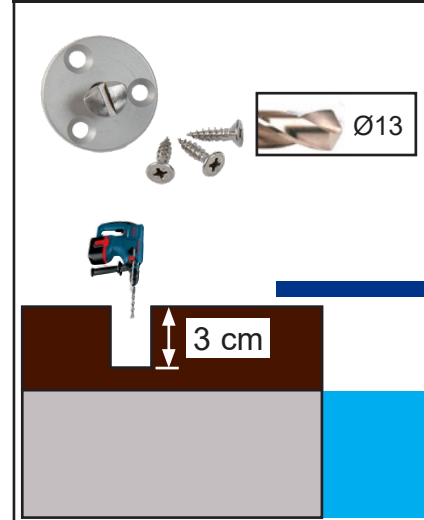

**i** Clean the drill holes with a vacuum cleaner.

## RECTANGULAR POOL

Drill then install by following the order shown on the diagrams.

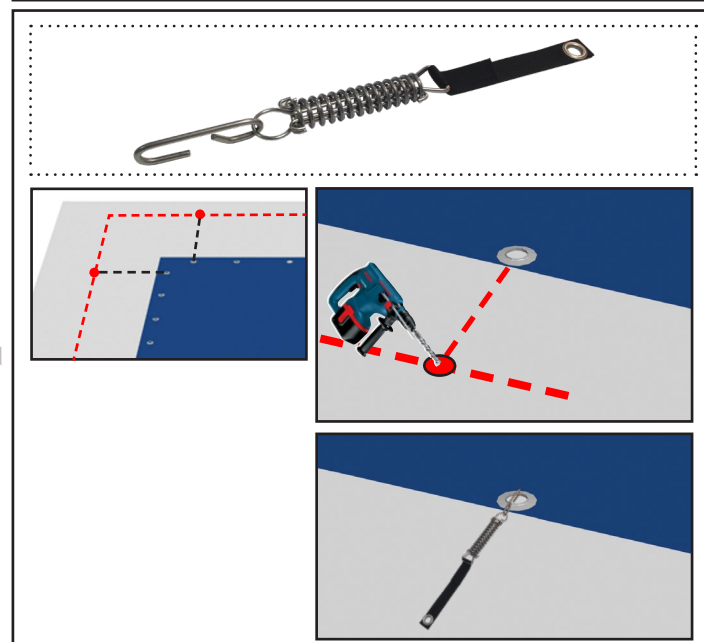
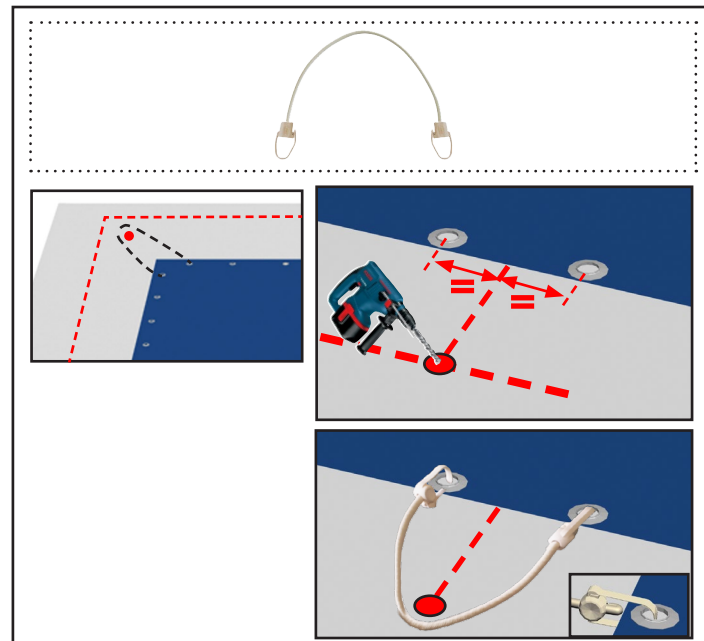
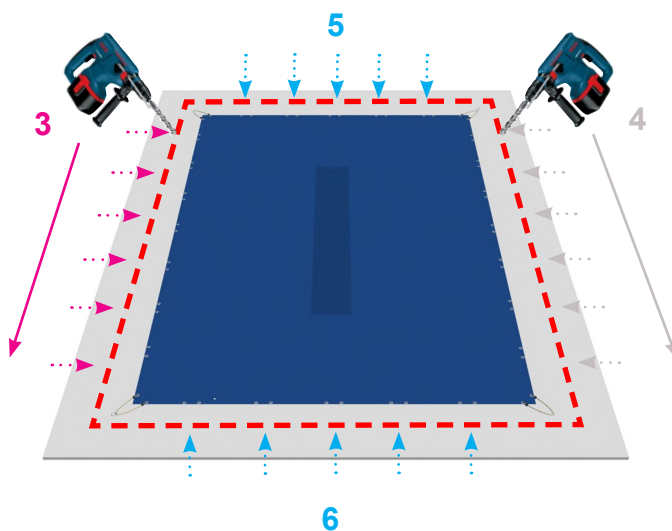
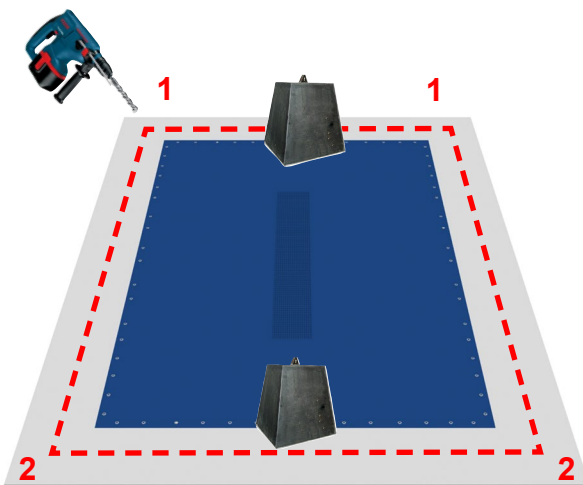

**i** Regularly check that the cover is taut

# FREE-FORM POOL

Drill then install by following the order shown on the diagrams.

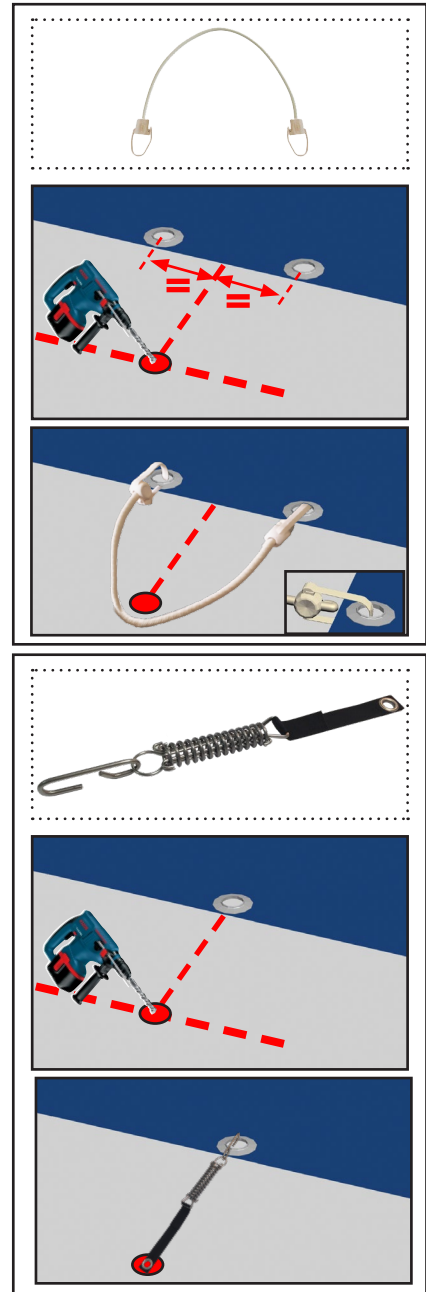
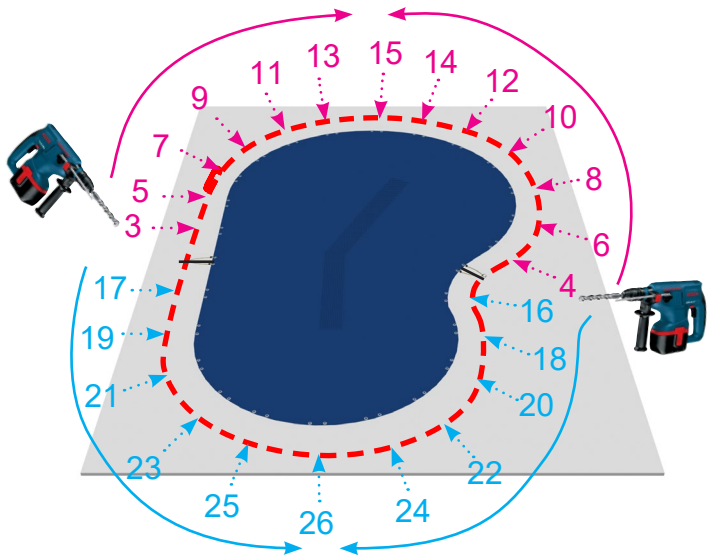
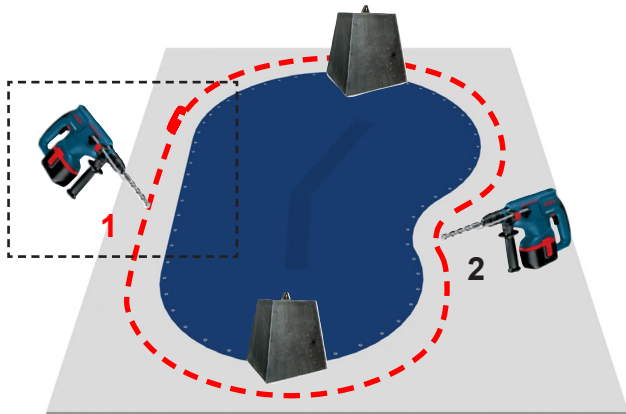

 Regularly check that the cover is taut

## CLOSING UP THE POOL

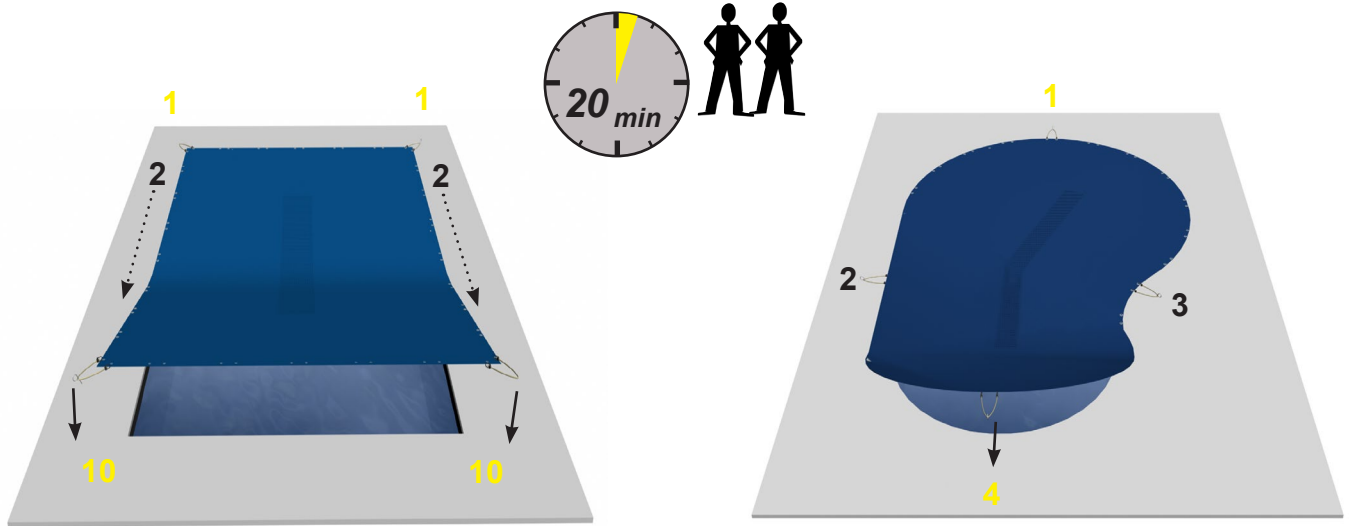

Attach the cover to the anchorages in chronological order.



Attach all anchorages

## OPENING UP THE POOL

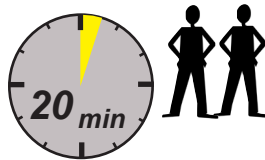

Unhook all the anchorages.  
 Slide the cover onto the deck.  
 Clean and dry the anchorages.  
 Clean and dry the cover before folding and storing in a dry place.  
 Pack everything away in the storage bag (OPTIONAL) and store in a dry, ventilated room away from light.

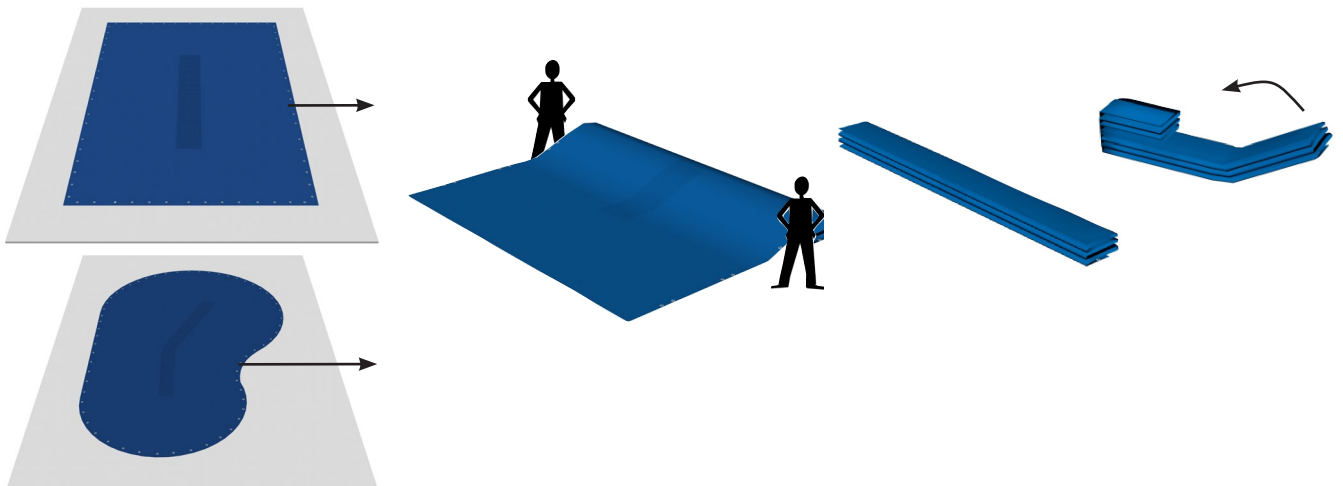

## WINTERING

- Close the cover.
- Do not lower the water level.
- Turn off the filtration.
- Remove snow regularly.

Warning, a covering of snow of more than 20 cm on the cover may cause irreversible damage to your equipment.

Installing a **"Support cable"** is recommended.

- If conditions are windy, weigh down the edges of the cover with water bladders or sandbags.

## UPKEEP (USER'S RESPONSIBILITY)

The correct upkeep of your winter cover is the best way to guarantee a long product lifetime.

Regularly clean the cover with a hose so that leaves do not accumulate and rot on top.

Do not use abrasives or solvents to clean the cover.

## MAINTENANCE

All maintenance operations must be performed by a professional, who will contact the manufacturer if necessary (details on the back of the document).

Only use original spare parts or parts compliant with the standard.

Regularly check the condition of the cover (click bungees, eyelet pegs, anchorages, springs, cover seams and welds ...) at the beginning and end of wintering, or following any type of accident.

Replace the defective parts if they are damaged.

In windy regions, particular attention must be paid to the cover rubbing on the surround caps.

The click bungees must be changed every 3 years.

date installed	
date click bungees are changed	
date click bungees are changed	
date click bungees are changed	

Introduction of the strap into the spring

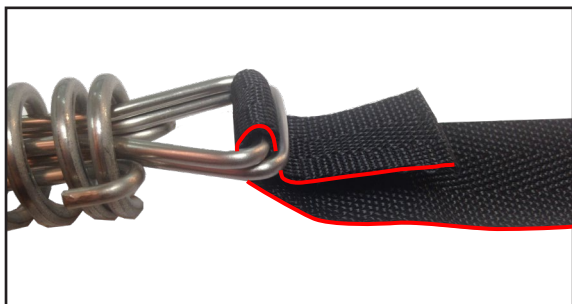

**DEAR CLIENTS,**

**THANK YOU FOR THE CONFIDENCE YOU HAVE PLACED IN US BY CHOOSING ONE OF OUR COVERS.**

**YOU ARE ADVISED TO CAREFULLY READ THE FOLLOWING RECOMMENDATIONS.**

**· YOUR POOL COULD BE A SERIOUS DANGER TO YOUR CHILDREN. DROWNING CAN OCCUR VERY QUICKLY.**

## **S A F E T Y T I P S**

**CHILDREN WHO ARE NEAR A SWIMMING POOL MUST BE CONSTANTLY AND ACTIVELY WATCHED, EVEN IF THEY KNOW HOW TO SWIM.**

**THE PHYSICAL PRESENCE OF A RESPONSIBLE ADULT IS ESSENTIAL WHEN THE POOL IS UNCOVERED.**

**LEARN LIFE-SAVING TECHNIQUES**

**MEMORISE THE EMERGENCY SERVICES' TELEPHONE NUMBERS AND DISPLAY THEM NEAR THE POOL.**

- FIRE BRIGADE: 18 (FOR FRANCE) OR 112 FROM A MOBILE PHONE**
- AMBULANCE SERVICE: 15 (FOR FRANCE)**
- POISON CONTROL CENTRE:**

**· THIS COVER IS NOT A SUBSTITUTE FOR COMMON SENSE OR INDIVIDUAL RESPONSIBILITY. IT IS ALSO NOT INTENDED TO REPLACE THE SUPERVISION OF RESPONSIBLE PARENTS AND/OR ADULTS WHO REMAIN THE ESSENTIAL FACTOR FOR THE PROTECTION OF YOUNG CHILDREN.**

**· RESPECT THE WATER LEVELS DEFINED BY THE MANUFACTURER.**

**· WARNING; SAFETY CAN ONLY BE GUARANTEED WITH A CLOSED AND LOCKED COVER THAT HAS BEEN CORRECTLY INSTALLED IN ACCORDANCE WITH THE MANUFACTURER'S INSTRUCTIONS.**

**· THE COVER MUST BE SYSTEMATICALLY INSTALLED EVEN WHEN THE HOME IS LEFT MOMENTARILY.**

**· ENSURE THAT NO FOREIGN OBJECTS OR SWIMMERS ARE IN THE POOL BEFORE AND DURING OPERATIONS WITH THE COVER**

**· STORE THE TOOLS FOR MANOEUVRING THE COVER OUT OF CHILDREN'S REACH.**

**· THE IMPLEMENTATION OF THE MECHANISM SHOULD ONLY BE UNDERTAKEN BY A RESPONSIBLE ADULT.**

**· CLIMBING, WALKING OR JUMPING ON THE SAFETY COVER ARE PROHIBITED.**

**· IF A MALFUNCTION OCCURS THAT PREVENTS THE POOL FROM BEING COVERED AND SECURED, OR IF POOL EQUIPMENT IS TEMPORARILY UNAVAILABLE, TAKE EVERY POSSIBLE MEASURE TO PREVENT YOUNG CHILDREN FROM ACCESSING THE POOL UNTIL THE COVER IS ABLE TO BE REPAIRED.**

**· CAREFULLY OBSERVE THE POOL DURING OPENING OR CLOSING OPERATIONS.**

**· A CHILD CAN DROWN IN LESS THAN 3 MINUTES; NO MEANS OF PROTECTION WILL EVER REPLACE THE SUPERVISION AND VIGILANCE OF A RESPONSIBLE ADULT.**



**SWIMMING POOL  
MANUFACTURER AND INSTALLER**